

# ALDIMA

Where Metal Meets Value

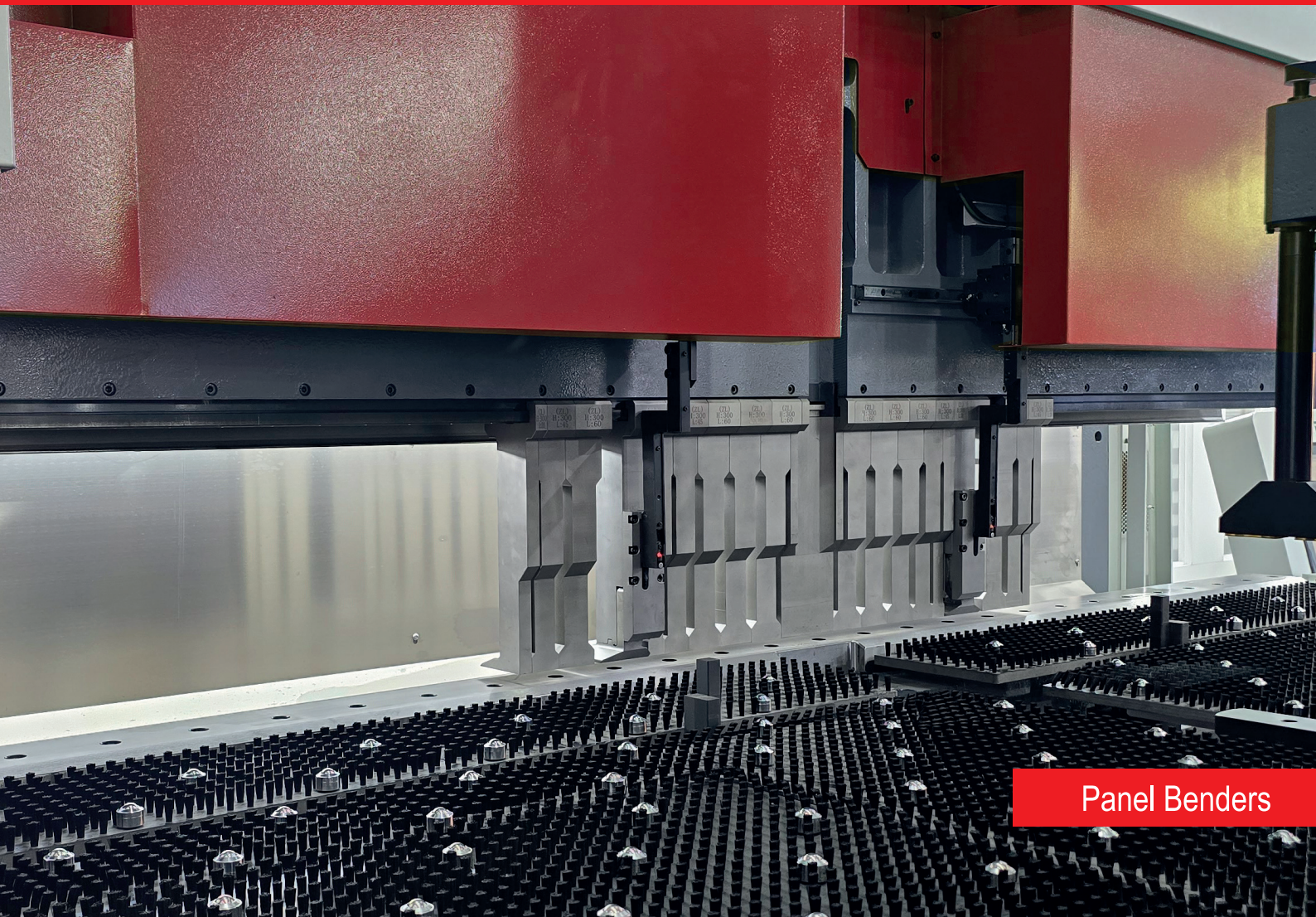

Panel Benders



With our experience in metal working machinery sector since 1996, the ALDIMA brand was founded in 2024 to redefine efficiency and cost-effectiveness in the metal working industry. At ALDIMA, we don't provide only machines, we provide solutions that add value to your production.

With precision engineering, robust performance, and a commitment to innovation, we help manufacturers turn sheet metal into quality results.

Whether you're shaping, cutting, or forming, our machines are designed to deliver accuracy, reliability, and long-term efficiency. So your business can focus on what really matters: growth, quality, and competitive edge.

With years of experience in precision mechanics and industrial innovation, our machines are trusted by global partners across sectors like automotive, construction and many other industries. The world wide most trusted and known brands are used at ALDIMA machines, such as Delem, ESA, Cybelec, Elgo, Bosch-Rexroth, Hoerbiger-HAWE, Givi, Heidenhain, Raycus, Raytools, Siemens, Schneider, Mitsubishi, Estun, Delta, Yaskawa, etc. ensure that our machines meet the highest performance standards.

We don't just ship machines. We export performance, reliability, and long-term value - so your production keeps moving forward.

**Where Metal Meets Value**



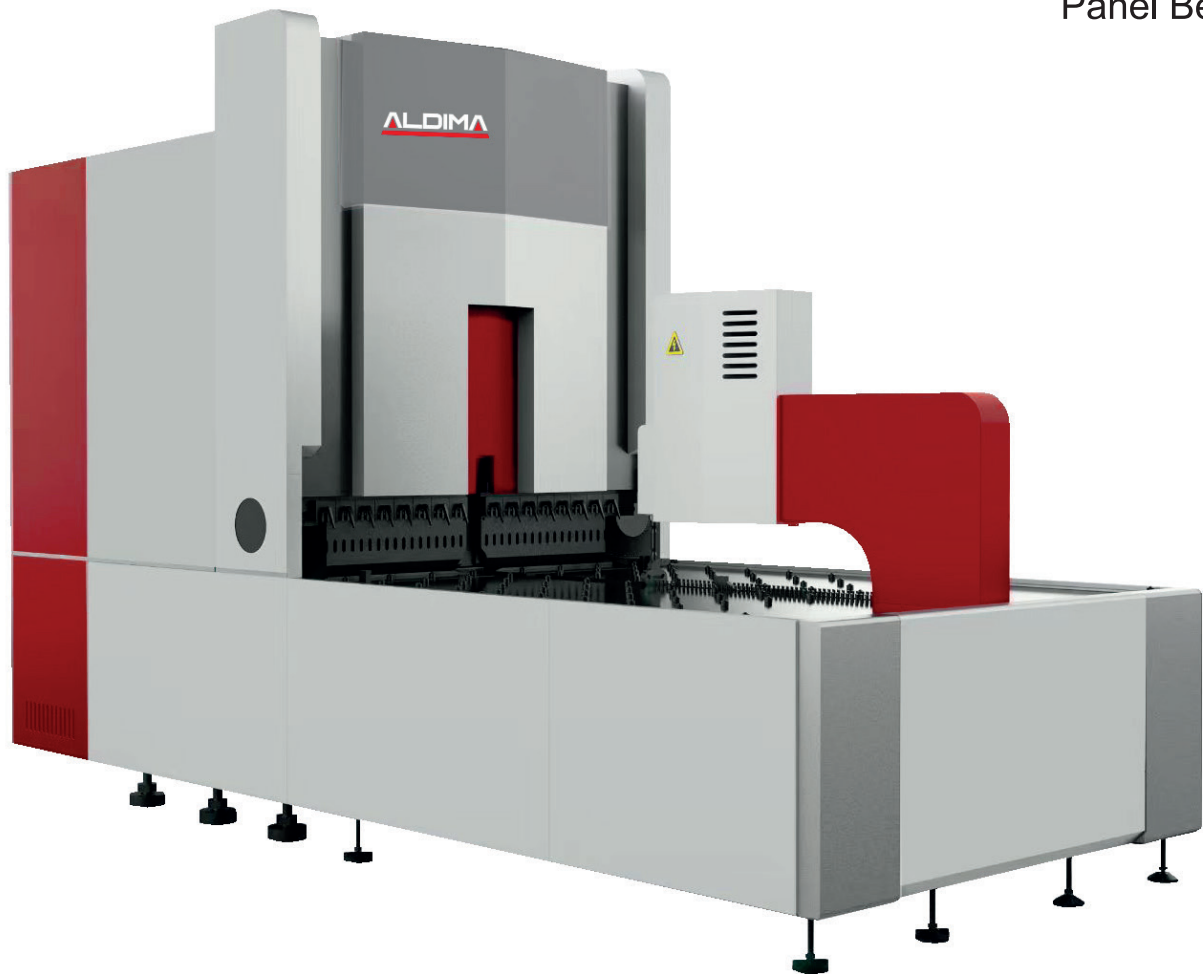

- Intelligent Servo Panel Bending – Fast, Flexible, and Fully Automated
- After years of dedicated R&D, our intelligent panel bender introduces a servo-electric flexible bending center that meets internationally advanced standards.
- Every aspect of the machine—from software and drivers to hardware circuits and mechanical components—has been independently developed to ensure full system integrity and technological innovation.
- As a non-hydraulic bending solution, the servo-electric panel bender offers outstanding speed, accuracy, repeatability, and reliability, making it ideal for high-performance sheet metal production.
- Engineered specifically for the sheet metal industry, this intelligent bending system helps manufacturers increase production efficiency, reduce labor intensity, and enhance their professional image.
- With fully automated panel processing, including automatic rotation of the workpiece, the operator's role is limited to loading and unloading—eliminating the need for manual guidance during bending.
- Thanks to the flexibility of its advanced bending head, the machine can perform positive, negative, radius, and flattening bends with ease—no manual handling required.
- Depending on the complexity of the parts, this system can replace the workload of up to three conventional bending machines, dramatically improving production output.



**Ball Screw**

Heavy load grinding grade screw rod is selected to ensure more stable transmission and higher accuracy.

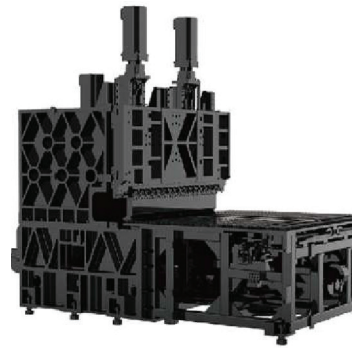

**High-Grade Cast Body**

-The core frame of the equipment is made of high grade QT500-7 and gray iron 250 castings.

-Long term operation is stable and reliable.

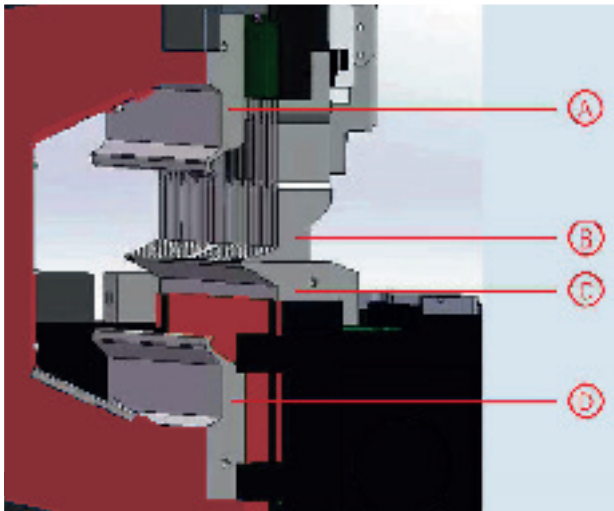

-The upper and lower bending tools (A, D) bend upward or downward during operation.

-The upper press tool (B) works simultaneously with the bending tool and the lower press tool to fix and bend the plate accurately and efficiently. The lower press tool (C) clamps the sheet during bending.

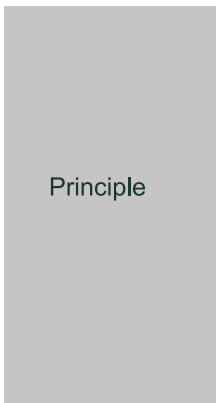

**Bending Operation**

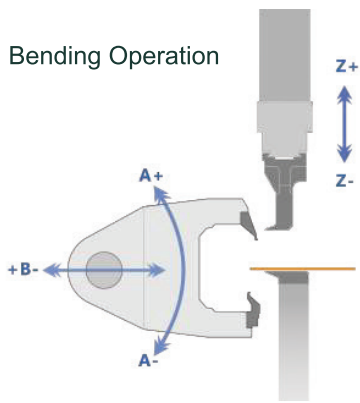

**Positive Bend**

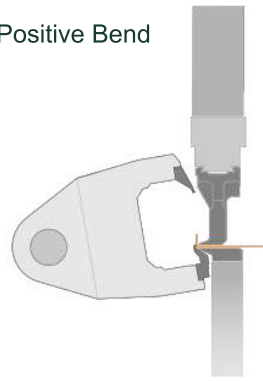

**Negative Bend**

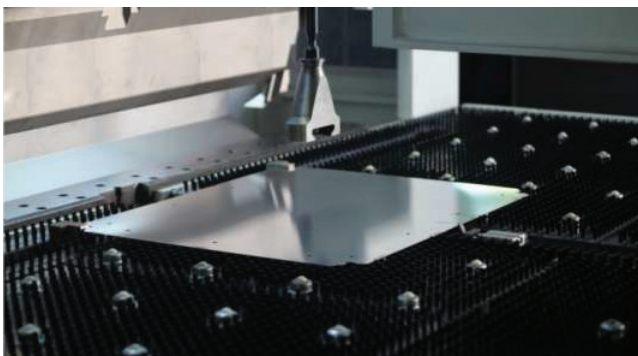
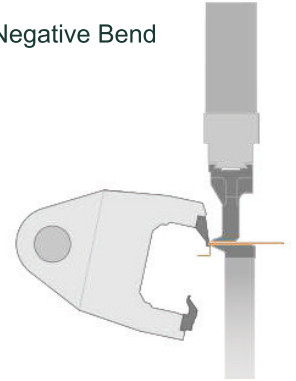

Pre-set material modes and precise secondary positioning of the machine tool enable smaller minimum sizes for more flexible movement.

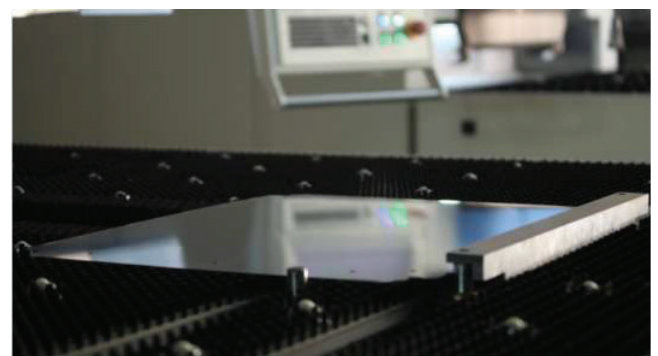

Compact machine structure, provides more space for material placement and eases material loading and unloading.

## Panel Bender

The machine features full electric servo control, in addition to high speed, efficiency, and precision, it also has the following advantages:

- ✓ One-time positioning for multi-sided bending
- ✓ Bending range from  $-45^{\circ}$  to  $+45^{\circ}$
- ✓ Special shapes and custom bending actions
- ✓ Automatically calculates sheet metal size, supports secondary positioning
- ✓ Supports bending downwards with the last bend on
- ✓ Automatic tool length adjustment for tool stacking

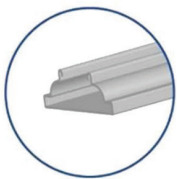

Arc

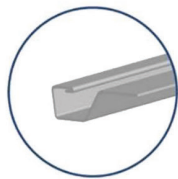

Hemming

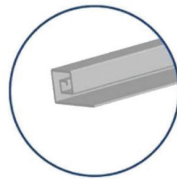

Hollow Square

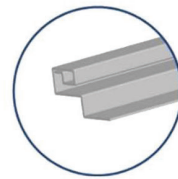

Closed

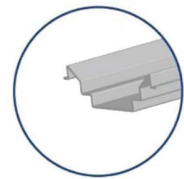

Complex

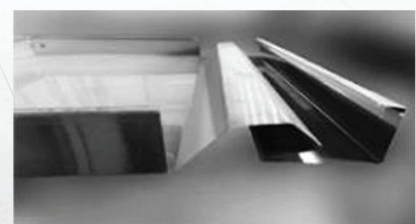
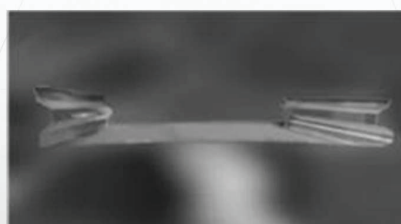
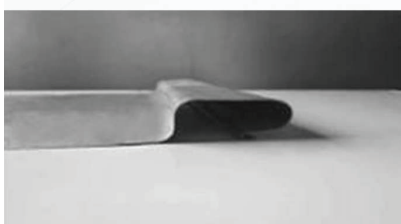
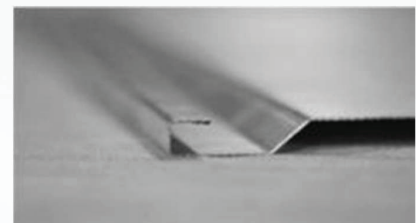
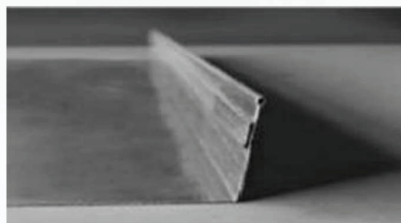
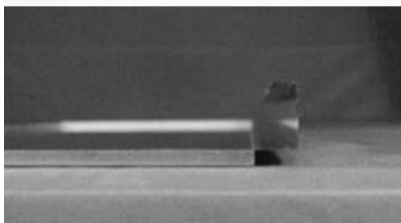
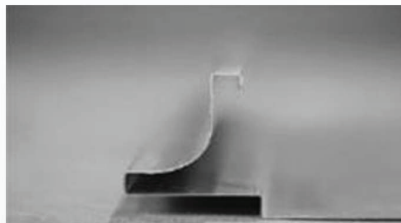
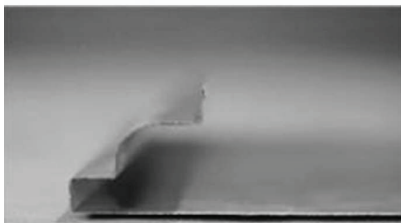
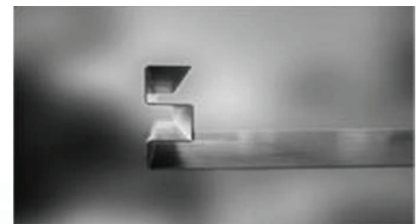
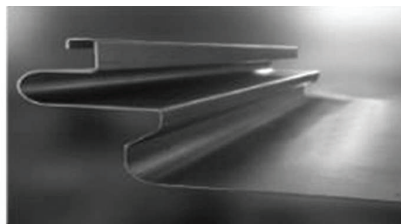
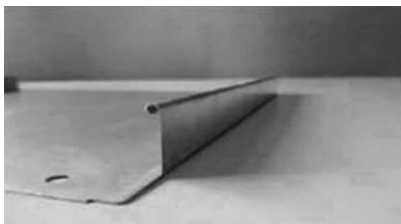

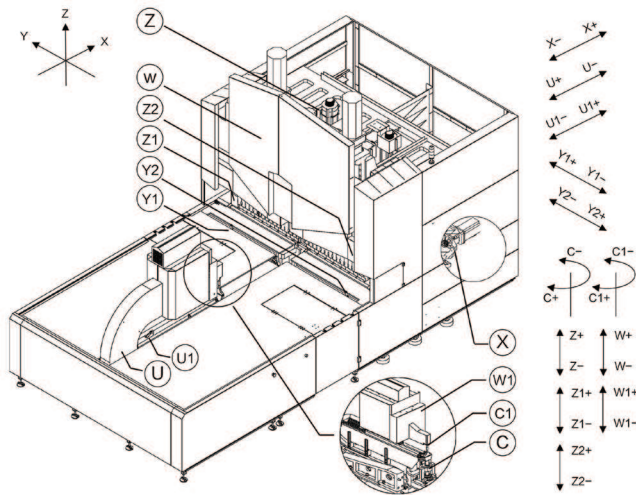

X-axis Controls the forward and backward movement of the bending blade (dual drive)

U-axis Controls the forward and backward movement of the press arm

U1-axis Controls the forward and backward movement of the front gauge

Y1-axis Controls the left Y-axis gauge movement to the left and right

Y2-axis Controls the right Y-axis gauge movement to the left and right

C-axis Controls the rotation of the C-axis clamp

C1-axis Controls the rotation of the C1-axis clamp

Z-axis Controls the upward and downward movement of the bending blade (dual drive)

Z1-axis Controls the upward and downward movement of the left powered hinge side blade

Z2-axis Controls the upward and downward movement of the right powered hinge side blade

W-axis Controls the upward and downward movement of the top blade (dual drive)

W1-axis Controls the upward and downward movement of the C1-axis clamp

	PB-M1600	PB-M2100	PB-M2600	PB-M3200
Feeding Structure	Press arm type	Press arm type	Press arm type	Press arm type
Workbench Structure	Brush	Brush	Brush	Brush
System Minimum Accuracy	0.001 mm	0.001 mm	0.001 mm	0.001 mm
Fastest Bending Speed	0.2sec / bending	0.2sec / bending	0.2sec / bending	0.2sec / bending
Max. Shipping Speed	90m/min	90m/min	90m/min	90m/min
Max. Bending Width	1600mm	2190mm	2600mm	3200mm
Max. Bending Size	L1600mm*W1200mm	L2190mm*W1200mm	L2600mm*W1200mm	L3200mm*W1200mm
Max. Bending Height	180mm	180mm	180mm	180mm
Maximum Bending Plate Thickness (mild steel)	1.5mm (450N/mm <sup>2</sup> )	2mm (450N/mm <sup>2</sup> )	2mm (450N/mm <sup>2</sup> )	2mm (450N/mm <sup>2</sup> )
Minimum Arc Radius	0.5mm	0.5mm	0.5mm	0.5mm
Rated Voltage	380V	380V	380V	380V
Total Motor Power	38KW	76KW	108KW	154KW
Average Power	27KW	54KW	76KW	110KW
Noise	50 decibel	50 decibel	50 decibel	50 decibel
Dimensions	L455cm*W275cm*H275cm	L565cm*W275cm*H320cm	L635cm*W301cm*H330cm	L690cm*W410cm*H350cm
Gross Weight	9T	21T	24T	30T
User Operating Environment	Win7 or above operating system	Win7 or above operating system	Win7 or above operating system	Win7 or above operating system
Maximum Bending Thickness	UTS 515N/mm <sup>2</sup> 201 SS 1.0mm UTS 410N/mm <sup>2</sup> MS 1.5mm UTS 265N/mm <sup>2</sup> AL 2.0mm	UTS 515N/mm <sup>2</sup> 201 SS 1.2mm UTS 410N/mm <sup>2</sup> MS 2mm UTS 265N/mm <sup>2</sup> AL 2.5mm	UTS 515N/mm <sup>2</sup> 201 SS 1.2mm UTS 410N/mm <sup>2</sup> MS 2.0mm UTS 265N/mm <sup>2</sup> AL 2.5mm	UTS 515N/mm <sup>2</sup> 201 SS 1.0mm UTS 410N/mm <sup>2</sup> MS 1.5mm UTS 265N/mm <sup>2</sup> AL 2.0mm
Minimum Material Thickness	0.35mm	0.35mm	0.35mm	0.35mm
Minimum Inner Dimensions of Four-Side Forming	280mmx180mm	280mmx180mm	280mmx180mm	280mmx180mm
Minimum Inner Dimension of Double-Sided Forming	180mm	180mm	180mm	180mm
Bending Angle	0-180 Degree	0-180 Degree	0-180 Degree	0-180 Degree
Number of Axes	15	15	15	15
Optional	Bending Height 300mm	Bending Height 300mm	Bending Height 300mm	Bending Height 300mm

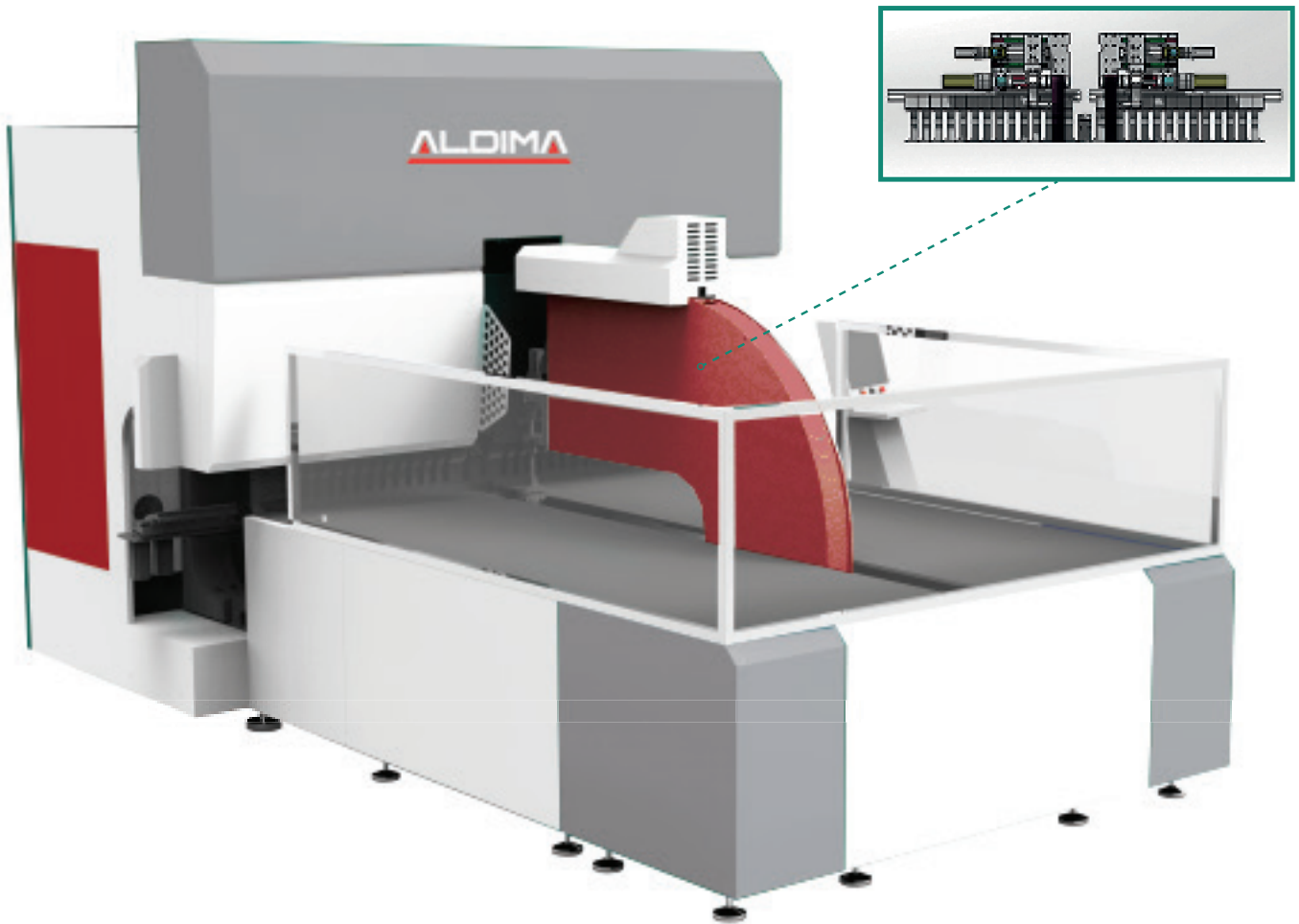

-The system employs a modular blade assembly with four-sided positioning capability. It supports different pressing widths on all four sides and enables eccentric bending and secondary positioning, achieving functionalities beyond standard bending centers. Tool changes are quick and smooth, taking only 0.5 seconds, ensuring precise bending.

-Featuring proprietary patented technology, the product requires positioning only once at the start of the bending process, eliminating the need for adjustments. The sheet metal and rotational structure remain constant during bending. With a resolution of 0.01 degrees, it guarantees high production flexibility. The fully automated bending process and versatile bending dies combine efficiency with adaptability, automatically accommodating various geometric shapes without the need for machine stoppage or manual die changes. This enables both batch and complete set production.

Utilizing automatic tool-changing bending technology, we have independently developed multi-axis concurrent motion control and a proprietary patented automatic tool assembly algorithm. This allows for automatic tool assembly when changing workpieces, offering high speed and precision. The maximum processing dimensions are 2600×1600 mm.

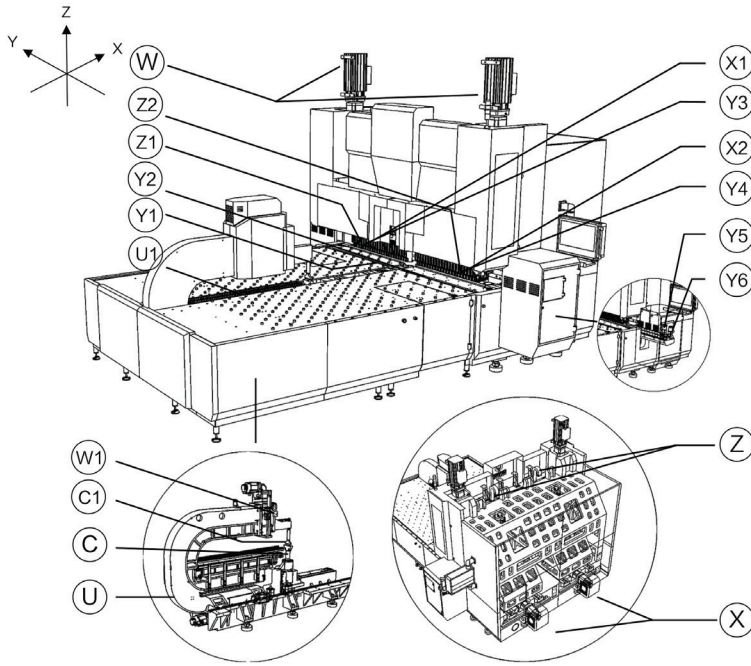

- X-axis Controls the forward and backward movement of the bending blade (dual drive)
- X1-axis Controls the forward and backward movement of the Z1 power folding blade holder
- X2-axis Controls the forward and backward movement of the Z2 power folding blade holder
- U-axis Controls the movement of the press arm forwards and backwards
- U1-axis Controls the movement of the front gauge forwards and backwards
- Y1-axis Controls the left Y-axis gauge left and right movement
- Y2-axis Controls the right Y-axis gauge left and right movement
- Y3-axis Controls the left and right movement of the Z1 power folding blade holder's tapping device
- Y4-axis Controls the left and right movement of the Z2 power folding blade holder's tapping device
- Y5-axis Controls the lateral movement of the left auxiliary blade
- Y6-axis Controls the lateral movement of the right auxiliary blade
- C-axis Controls the rotation of the C-axis clamp
- C1-axis Controls the rotation of the C1-axis clamp
- Z-axis Controls the upward and downward movement of the bending blade (dual drive)
- Z1-axis Controls the upward and downward movement of the left powered hinge knife side blade
- Z2-axis Controls the upward and downward movement of the right powered hinge knife side blade
- W-axis Controls the upward and downward movement of the top blade (dual drive)
- W1-axis Controls the upward and downward movement of the C1-axis clamp

PROJECT / PROJE	Unit Birim	PB+1600	PB+2100	PB+2600
Bending Length	mm	1630	2190	2610
Bending Height	mm	200	200	200
Minimum Size For Four-Sided Forming	mm	370*180	370*180	370*180
Minimum Size For Two-Sided Forming	mm	180	180	180
Minimum Bending Height	mm	4	6	6
Minimum Arc Radius	mm	4	4	4
Maximum Forming Size	mm	1600*1300	2200*1300	2470*1300
Bending Angle	°	-90°~180°	-90°~180°	-90°~180°
Bending Speed	sec/time	0.2	0.2	0.2
Number of Axes	m/min	22	24	24
Mild Steel	mm	2	2	2
Stainless Steel	mm	1.5	1.5	1.5
Aluminum Sheet	mm	3.5	3.5	3.5
Galvanized Steel Sheet	mm	2	2	2
Hot Rolled Steel Sheet	mm	2	2	2
Feeding Structure	-	Pressure arm	Pressure arm	Pressure arm
Maximum Feeding Speed	m/min	800	800	800
Tool Changing Method	-	Automatic	Automatic	Automatic
Upper and Lower Auxiliary Blades	-	Optional	Optional	Optional
Worktable Structure	-			
Total Power	kW	44	77	103
Peak Power	kW	43	83	118
Overall Dimensions (L*W*H)	mm	4550*2750*2750	5650*3650*3150	6200*4100*3350
Total Weight	t	10t	22t	28t



Where Metal Meets Value

Alaaddinbey Mh. 646 Sk. No. 8/A 16285 Nilüfer - Bursa / Türkiye  
Tel. : +90 (224) 249 77 35 Fax : +90 (224) 249 77 48  
E-mail : [info@aldima.com.tr](mailto:info@aldima.com.tr) [www.aldima.com.tr](http://www.aldima.com.tr)